

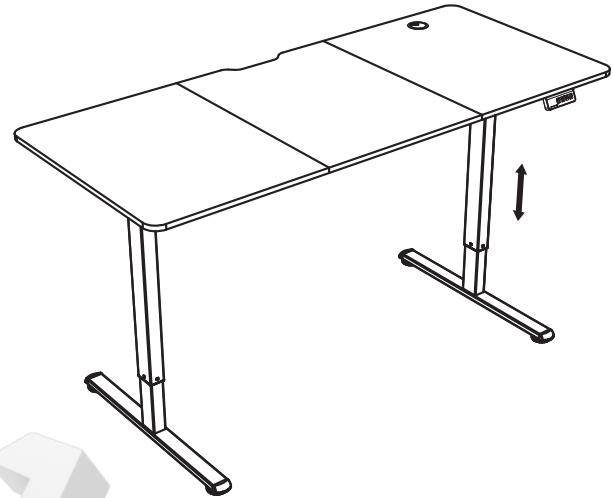

Dive into your next dimension



Find out more about us at
www.xyzpcgear.com

XYZ CORE DESK

X-DS-CORE-B

Instructions manual





Dive into your next dimension

Instruction Manual

Manual de Instruções

Manual de Instrucciones

Mode d'Emploi

Manuale di Istruzioni

Bedienungsanleitung

使用说明书



COMPONENTS | COMPONENTES | COMPONENTES
 COMPOSANTS | COMPONENTI | KOMONENTEN | 组件

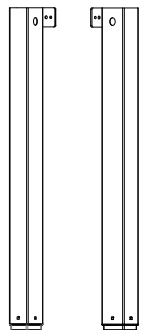

B1 X1 **B2** X1

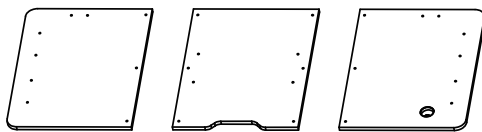

B3-1 X1 **B3-2** X1 **B3-3** X1

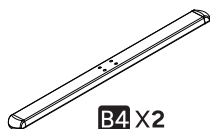

B4 X2

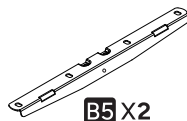

B5 X2

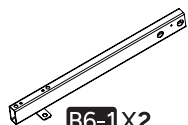

B6-1 X2



B6-2 X2



B6-3 X2



B7 X1



B8 X1

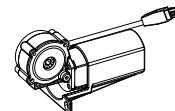

B9 X1

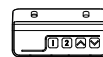

B10 X1



B11 X1



B12 X1



B13 X4



B14 X6



B15 X1

a X8



M6x10mm

b X4



M8x14mm

c X8



M6x35mm

d X34



M6x12mm

e X2



M4x38mm

f X8



g X1



h X1



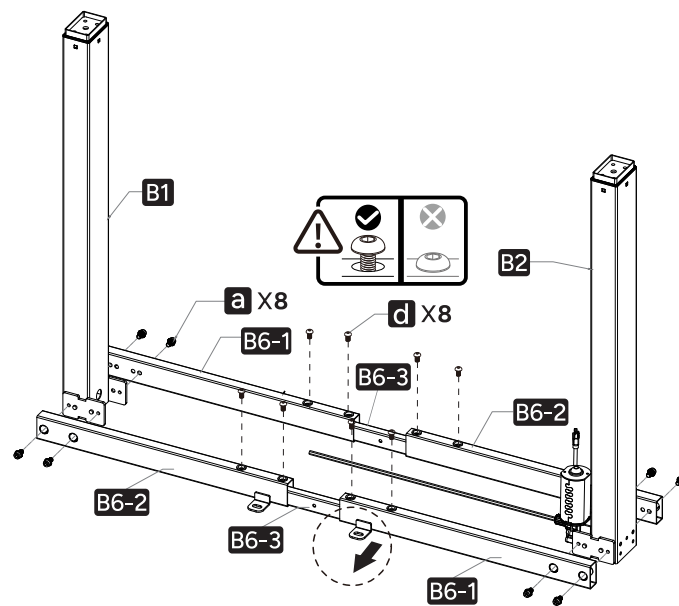
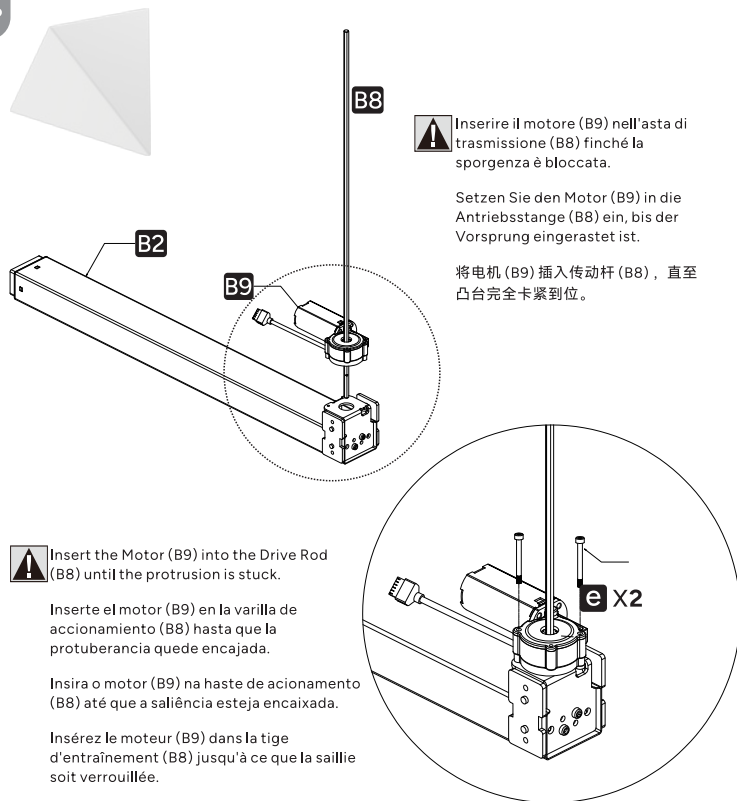

1
STEP

ASSEMBLY | MONTAJE | MONTAGEM
ASSEMBLAGE | MONTAGGIO | MONTAGE | 组装

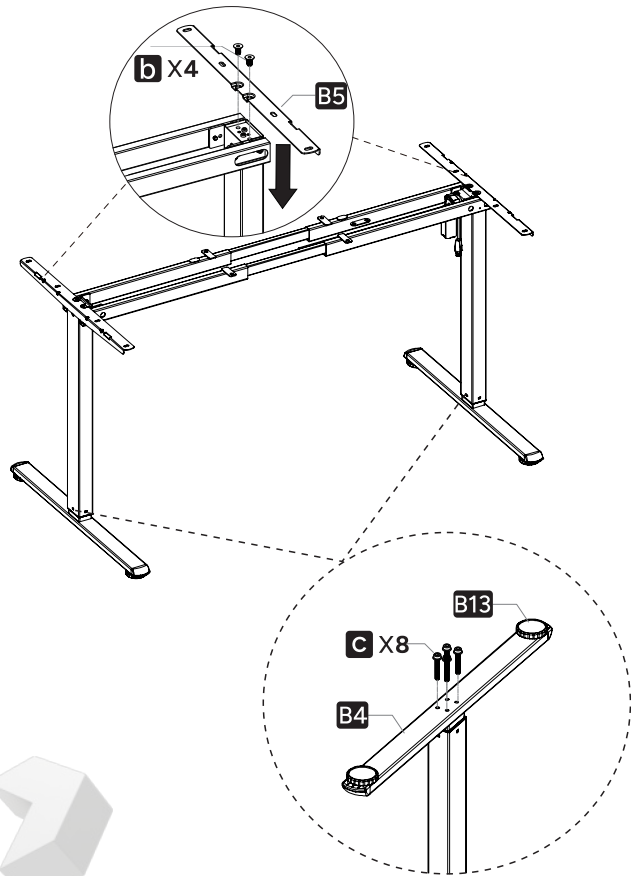
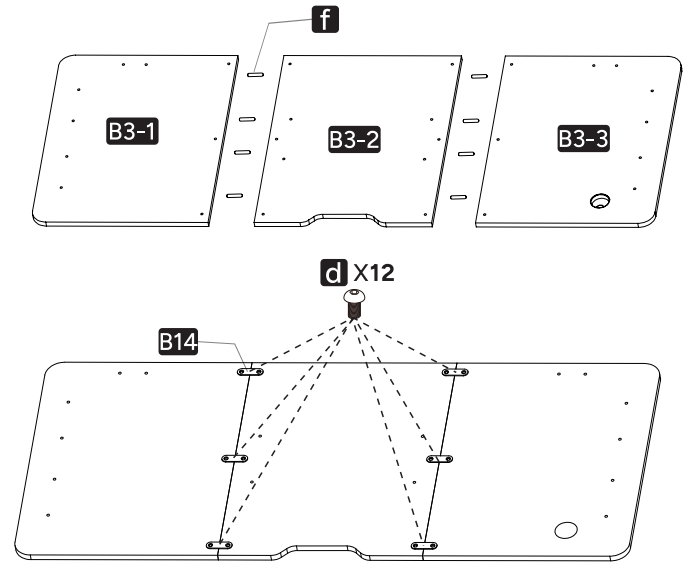
2
STEP

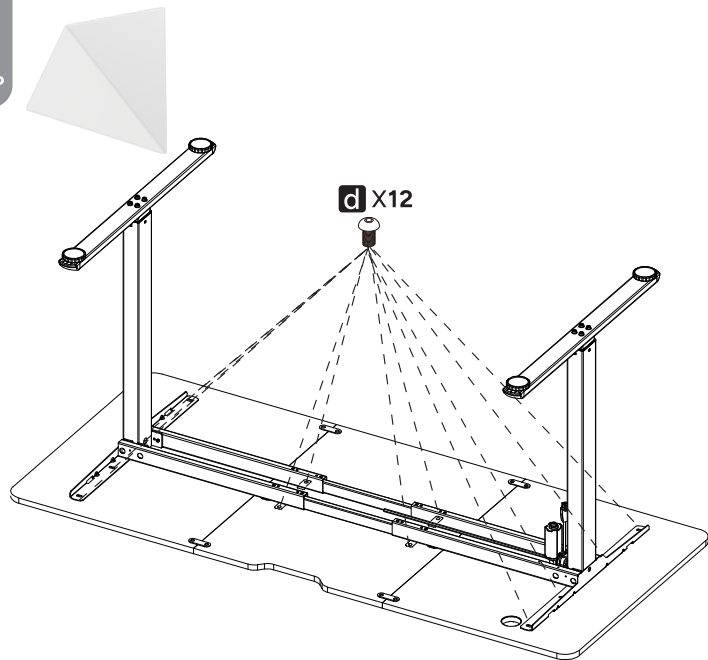
3
STEP4
STEP

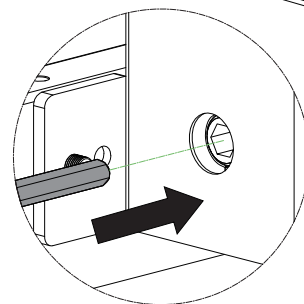
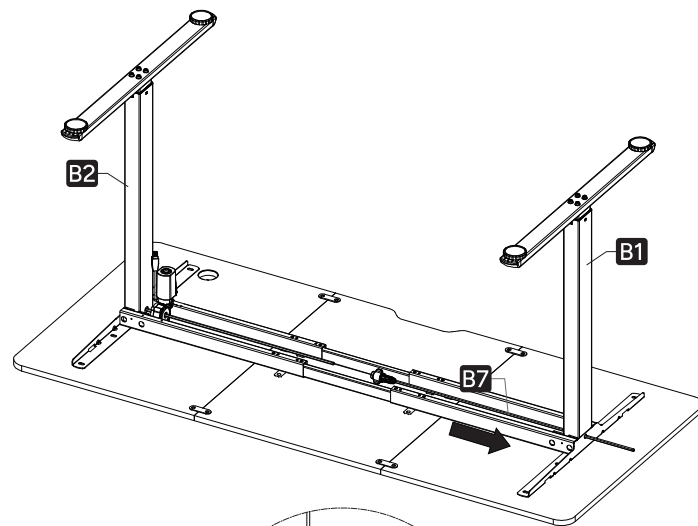
5
STEP1.5. 
6
STEP

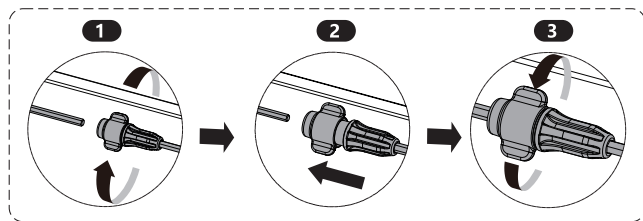

! Stellen Sie sicher, dass die Beine B1 und B2 die gleiche Höhe haben. Falls nicht, setzen Sie die Antriebsstange B7 in das Bein B1 ein und drehen Sie dann die Antriebsstange B7, sodass B1=B2 ist.
 请确保桌腿 B1 与 B2 高度一致。若高度不一致, 请将传动杆 B7 插入桌腿 B1 中, 旋转传动杆 B7, 直至 B1 与 B2 高度相等。

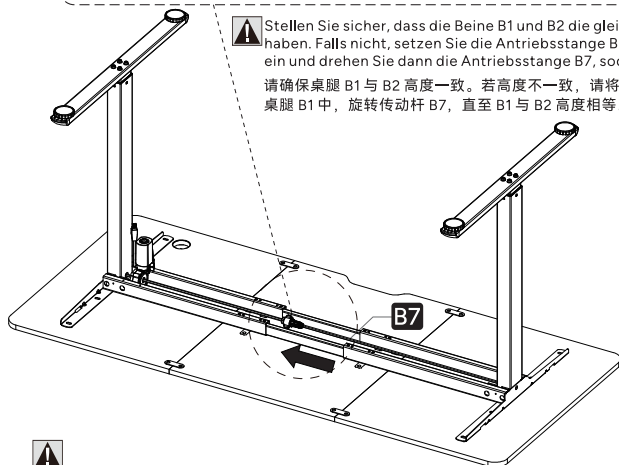

Make sure B1 and B2 legs are the same height. If not, please insert the B7 Drive Rod into the B1 leg, then rotate the B7 Drive Rod to make B1=B2.

Asegúrese de que las patas B1 y B2 tengan la misma altura. Si no es así, inserte la varilla de accionamiento B7 en la pata B1, luego gire la varilla de accionamiento B7 para que B1=B2.

Certifique-se de que as pernas B1 e B2 tenham a mesma altura. Caso contrário, insira a haste de acionamento B7 na perna B1, depois gire a haste de acionamento B7 para que B1=B2.

Assurez-vous que les pieds B1 et B2 sont de la même hauteur. Si ce n'est pas le cas, insérez la tige d'entraînement B7 dans le pied B1, puis faites tourner la tige d'entraînement B7 pour que B1=B2.

Assicurarsi che le gambe B1 e B2 abbiano la stessa altezza. In caso contrario, inserire l'asta di trasmissione B7 nella gamba B1, quindi ruotare l'asta di trasmissione B7 per ottenere B1=B2.

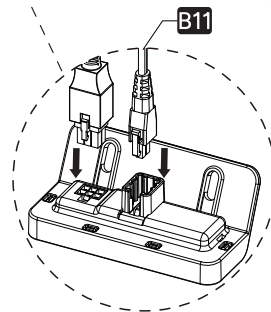
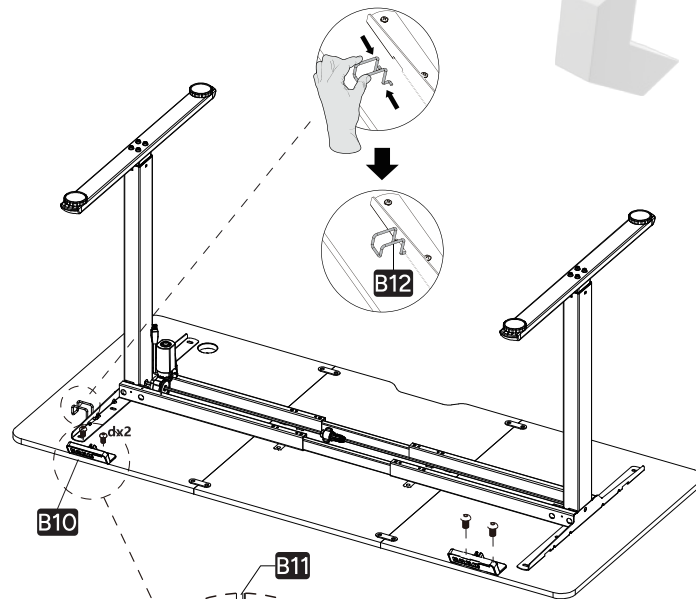

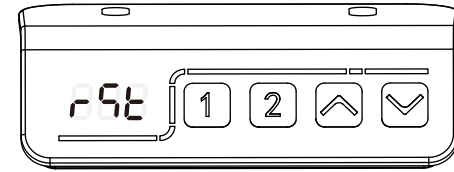
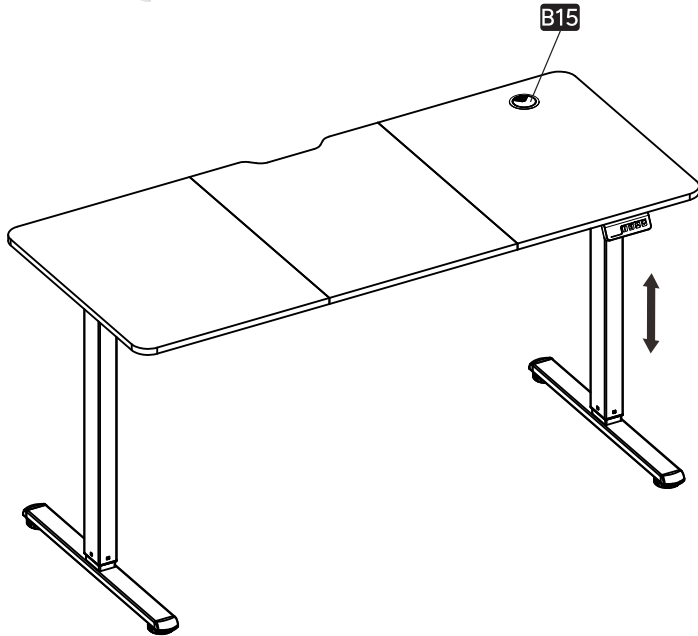

EN



If the left side doesn't go up/down when using the desk, go back to step 6-7. Make sure the drive rod is installed correctly.

IMPORTANT! You must Reset the desk prior to use:

Press and hold the "✓" button on the Handset until the desk reaches its lowest height. Release the "✓" button.

Press and hold the "✓" button again for more than 3 seconds until "75cm" is displayed. Release the "✓" button.

Press and hold the "✓" button until the desk lowers a little bit more, slightly rises and stops. Release the "✓" button. The handset will then display the current height.

Your desk is now ready to use.

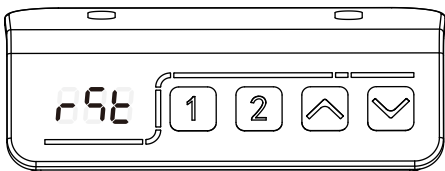

PT



Se o lado esquerdo não subir/descer ao usar a secretária, volte aos passos 6-7. Certifique-se de que a haste motriz está instalada corretamente.

IMPORTANTE! Tem que Reiniciar a secretária antes de usar:

Mantenha premido o botão "Ⓜ" no comando até que a secretária chegue à sua altura mínima. Solte o botão "Ⓜ".

Mantenha premido o botão "Ⓜ" novamente por mais de 3 segundos até que "r 5t" seja exibido. Solte o botão "Ⓜ".

Mantenha premido o botão "Ⓜ" até que a secretária baixe um pouco mais, suba ligeiramente e pare. Solte o botão "Ⓜ". O comando irá então exibir a altura atual.

A sua secretária está pronta para usar.

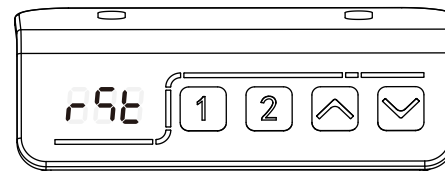

ES



Si el lado izquierdo no sube/baja al usar el escritorio, vuelve a los pasos 6-7. Asegúrate de que la varilla de accionamiento está instalada correctamente.

¡IMPORTANTE! Debes Reiniciar el escritorio antes de usarlo:

Mantén pulsado el botón "Ⓜ" en el mando hasta que el escritorio alcance su altura más baja. Suelta el botón "Ⓜ".

Mantén pulsado el botón "Ⓜ" de nuevo durante más de 3 segundos hasta que se muestre "r 5t". Suelta el botón "Ⓜ".

Mantén pulsado el botón "Ⓜ" hasta que el escritorio baje un poco más, se eleve ligeramente y se detenga. Suelta el botón "Ⓜ".

El mando mostrará entonces la altura actual. Tu escritorio ya está listo para usar.

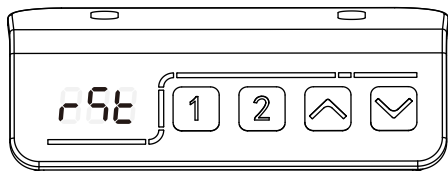

FR



Si le côté gauche ne monte/pas descend lors de l'utilisation du bureau, revenez aux étapes 6-7. Assurez-vous que la tige d'entraînement est correctement installée.

IMPORTANT ! Vous devez Réinitialiser le bureau avant de l'utiliser :

Maintenez enfoncé le bouton "Ⓜ" sur le combiné jusqu'à ce que le bureau atteigne sa hauteur la plus basse. Relâchez le bouton "Ⓜ".

Maintenez enfoncé le bouton "Ⓜ" à nouveau pendant plus de 3 secondes jusqu'à ce que "r 5t" s'affiche. Relâchez le bouton "Ⓜ".

Maintenez enfoncé le bouton "Ⓜ" jusqu'à ce que le bureau descende un peu plus, remonte légèrement et s'arrête. Relâchez le bouton "Ⓜ".

Le combiné affichera alors la hauteur actuelle.
Votre bureau est maintenant prêt à l'emploi.

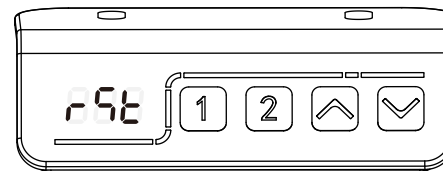

IT



Se il lato sinistro non sale/scende durante l'uso della scrivania, torna ai passaggi 6-7. Assicurati che l'asta di trasmissione sia installata correttamente.

IMPORTANTE! È necessario Ripristinare la scrivania prima dell'uso:

Tieni premuto il pulsante "Ⓜ" sul portatile fino a quando la scrivania raggiunge la sua altezza minima. Rilascia il pulsante "Ⓜ".

Tieni premuto nuovamente il pulsante "Ⓜ" per più di 3 secondi fino a quando viene visualizzato "r 5t". Rilascia il pulsante "Ⓜ".

Tieni premuto il pulsante "Ⓜ" fino a quando la scrivania scende un po' di più, si alza leggermente e si ferma. Rilascia il pulsante "Ⓜ".

Il portatile visualizzerà quindi l'altezza corrente.
La tua scrivania è ora pronta per l'uso.

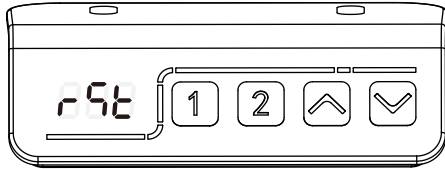

DE

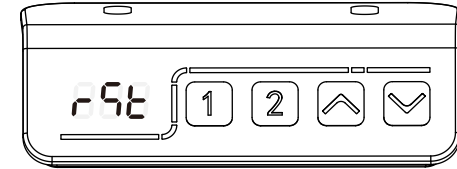

ZH







Wenn die linke Seite beim Benutzen des Schreibtisches nicht hoch/runter fährt, gehen Sie zurück zu den Schritten 6-7. Stellen Sie sicher, dass die Antriebsstange korrekt installiert ist.





使用升降桌时若左侧无法升降, 请返回步骤 6-7 操作。请确保传动连杆安装正确。

WICHTIG! Sie müssen den Schreibtisch vor der Nutzung zurücksetzen:

Halten Sie die Taste  am Handset gedrückt, bis der Schreibtisch seine niedrigste Höhe erreicht hat. Lassen Sie die Taste  los.



Halten Sie die Taste  erneut länger als 3 Sekunden gedrückt, bis "r 5t" angezeigt wird. Lassen Sie die Taste  los.

Halten Sie die Taste  gedrückt, bis der Schreibtisch ein wenig weiter absinkt, leicht ansteigt und stoppt. Lassen Sie die Taste  los.

Das Handset zeigt dann die aktuelle Höhe an.
Ihr Schreibtisch ist jetzt betriebsbereit.

重要!使用前必须对升降桌进行复位:

按住手控器上的  键, 直至桌面降至最低位置, 松开  键。

再次按住  键超过 3 秒 "r 5t", 直至屏幕显示 RESET, 松开  键。

继续按住  键, 直至桌面再小幅下降、轻微上升后停止, 松开  键。

此时手控器将显示当前高度。升降桌已准备就绪, 可以使用。

Digital Control Panel For Electric Height Adjustable Desk User Guide

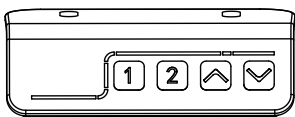

EN

Lifting Function

Press the "▲" button, the desk will rise automatically and stop automatically when it rises to the highest point. Press the "▼" button, the desk will descend and stop automatically when it descends to the lowest point.

Memory Mode

To store a certain height in the controller's memory, press the "1" button for more than three seconds. "5-1" will be displayed, indicating that the current height has been saved to the "1" button successfully. Repeat the process using button "2".

Reset Mode

1. If the height of the desk is incorrect, press the "▼" until the desk moves to the fully lowered position. Press and hold the "▼" again for at least three seconds and release. "r 5t" will be displayed. Continue holding until the desk goes down to its lowest level and comes back up slightly.

2. If the system displays "Er 1", press and hold the "▼" for more than three seconds and release. "r 5t" will be displayed, then continue the reset operation.

Child Lock

TO LOCK: Press and hold the "▲" and the "▼" simultaneously for five seconds until the LED reads "Loc".

TO UNLOCK: Press and hold the "▲" and the "▼" simultaneously for five seconds until the LED switches from "Loc" to the height display.

Painel de Controle Digital para Mesa Elétrica Ajustável em Altura Guia do Utilizador

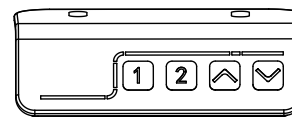

PT

Função de Levantamento

Ao pressionar o botão "▲", a mesa subirá automaticamente e parará ao atingir o ponto mais alto. Ao pressionar o botão "▼", a mesa descerá automaticamente e parará ao atingir o ponto mais baixo.

Modo de Memória

Para armazenar uma determinada altura na memória do controlador, pressione o botão "1" por mais de três segundos. Será exibido "5-1", indicando que a altura atual foi salva com sucesso no botão "1". Repita o processo usando o botão "2".

Modo de Reinicialização

1. Se a altura da mesa estiver incorreta, pressione o botão "▼" até que a mesa desça completamente para a posição mais baixa. Pressione e segure o botão "▼" novamente por pelo menos três segundos e solte. Será exibido "r 5t". Continue segurando até que a mesa desça ao nível mais baixo e volte a subir ligeiramente.

2. Se o sistema exibir "Er 1", pressione e segure o botão "▼" por mais de três segundos e solte. Será exibido "r 5t", depois continue a operação de reinicialização.

Trava de Segurança para Crianças

TRANCAR: Pressione e segure simultaneamente os botões "▲" e "▼" por cinco segundos até que o LED mostre "Loc". DES

TRANCAR: Pressione e segure simultaneamente os botões "▲" e "▼" por cinco segundos até que o LED mude de "Loc" para a exibição da altura.

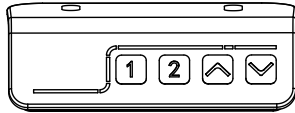

Painel de Control Digital para Mesa Eléctrica Ajustable en Altura

Guía del Usuario





ES



Función de Elevación

Al presionar el botón , el escritorio se elevará automáticamente y se detendrá al alcanzar el punto más alto. Al presionar el botón , el escritorio descenderá automáticamente y se detendrá al alcanzar el punto más bajo.

Modo de Memoria



Para almacenar una altura determinada en la memoria del controlador, presione el botón  durante más de tres segundos. Se mostrará "5-1", indicando que la altura actual se ha guardado correctamente en el botón . Repita el proceso con el botón .



Modo de Reinicio

1. Si la altura del escritorio es incorrecta, presione el botón  hasta que el escritorio baje completamente a la posición más baja. Vuelva a presionar y mantener el botón  durante al menos tres segundos y luego suéltelo. Se mostrará "r 5t". Continúe manteniendo hasta que el escritorio baje a su nivel más bajo y vuelva a subir ligeramente.

2. Si el sistema muestra "Er 1", presione y mantenga el botón  durante más de tres segundos y suéltelo. Se mostrará "r 5t", luego continúe con la operación de reinicio.

Bloqueo Infantil

BLOQUEAR: Presione y mantenga simultáneamente los botones  y  durante cinco segundos hasta que el LED muestre "Loc".

DESbloQUEAR: Presione y mantenga simultáneamente los botones  y  durante cinco segundos hasta que el LED cambie de "Loc" a la visualización de la altura.

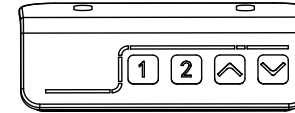

Pannello di Controllo Digitale per Scrivania Elettrica Regolabile in Altezza

Manuale Utente





IT



Funzione di Sollevamento

Premendo il pulsante , la scrivania si alzerà automaticamente e si fermerà al raggiungimento del punto più alto. Premendo il pulsante , la scrivania si abbasserà automaticamente e si fermerà al raggiungimento del punto più basso.

Modalità Memoria



Per memorizzare una determinata altezza nella memoria del controller, tenere premuto il pulsante  per più di tre secondi. Verrà visualizzato "5-1", indicando che l'altezza corrente è stata salvata correttamente sul pulsante . Ripetere la procedura con il pulsante .



Modalità Ripristino

1. Se l'altezza della scrivania è errata, premere il pulsante  finché la scrivania non scende completamente nella posizione più bassa. Tenere premuto nuovamente il pulsante  per almeno tre secondi e rilasciare. Verrà visualizzato "r 5t". Continuare a tenere premuto finché la scrivania non scende al livello più basso e risale leggermente.

2. Se il sistema visualizza "Er 1", tenere premuto il pulsante  per più di tre secondi e rilasciare. Verrà visualizzato "r 5t", quindi continuare l'operazione di ripristino.

Blocco Bambini

BLOCCARE: Tenere premuti simultaneamente i pulsanti  e  per cinque secondi finché il LED non visualizza "Loc".

SBLOCCARE: Tenere premuti simultaneamente i pulsanti  e  per cinque secondi finché il LED non passa da "Loc" alla visualizzazione dell'altezza.

Digitales Bedienfeld für Elektrisch Höhenverstellbaren Schreibtisch

Bedienungsanleitung

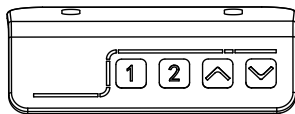

DE

Hebefunktion

Drücken Sie die Taste : Der Schreibtisch fährt automatisch hoch und stoppt am höchsten Punkt. Drücken Sie die Taste : Der Schreibtisch fährt automatisch herunter und stoppt am niedrigsten Punkt.

Speichermodus

Um eine bestimmte Höhe im Speicher des Controllers zu speichern, drücken Sie die Taste länger als drei Sekunden. "" wird angezeigt und bedeutet, dass die aktuelle Höhe erfolgreich auf der Taste gespeichert wurde. Wiederholen Sie den Vorgang mit der Taste .

Reset-Modus

1. Wenn die Höhe des Schreibtisches falsch angezeigt wird, drücken Sie die Taste , bis der Schreibtisch vollständig in die unterste Position gefahren ist. Halten Sie die Taste erneut mindestens drei Sekunden lang gedrückt und lassen Sie sie dann los. "" wird angezeigt. Halten Sie weiter gedrückt, bis der Schreibtisch auf sein niedrigstes Niveau gefahren ist und leicht wieder hochfährt.

2. Wenn das System "" anzeigt, halten Sie die Taste länger als drei Sekunden gedrückt und lassen Sie sie dann los. "" wird angezeigt, dann setzen Sie den Reset-Vorgang fort.

Kindersicherung

SICHERN: Halten Sie gleichzeitig die Tasten und fünf Sekunden lang gedrückt, bis die LED "" anzeigt.

ENTSICHERN: Halten Sie gleichzeitig die Tasten und fünf Sekunden lang gedrückt, bis die LED von "" zur Höhenanzeige wechselt.

电动升降桌数字控制面板 使用说明书

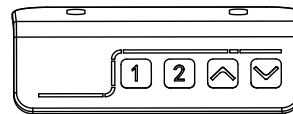

ZH

升降功能

按下 按钮，桌面将自动上升，到达最高点时自动停止。

按下 按钮，桌面将自动下降，到达最低点时自动停止。

记忆模式

若要将某一高度保存到控制器内存中，长按 按钮超过 3 秒。屏幕将显示 ""，表示当前高度已成功保存到 按钮。使用 按钮重复此过程。

重置模式

1. 若桌面高度显示不正确，按下 直至桌面完全降至最低位置。再次长按 至少 3 秒后松开，屏幕将显示 ""。继续按住，直到桌面降至最低点并略微回升。

2. 若系统显示 ""，长按 超过 3 秒后松开，屏幕将显示 ""，然后继续执行重置操作。

儿童锁

锁定：同时长按 和 5 秒，直到 LED 显示 ""。

解锁：同时长按 和 5 秒，直到 LED 从 "" 切换回高度显示。

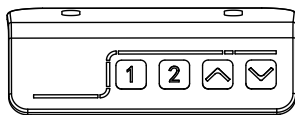

EN

ADVANCED SETTING

Press and hold the "1" button and the "2" button simultaneously for 20 seconds until the LED flashes. The menu contains 7 items as the table below.

Press on "▲" or "▼" to perform settings respectively; press and hold the "1" button and the "2" button for no less than 5 seconds until the "888" is displayed to have current setting saved.

Menu	Setting Range	Remarks
Minimum Height	73cm-108cm (28.7"-42.5")	The setting value should be at least 10cm (3.9") less than the Maximum Height.
Maximum Height	83cm-118cm (32.7"-46.5")	The setting value should be at least 10cm (3.9") less than the Maximum Height.
Starting Height	0cm-30cm (0"-11.8")	Increase the Starting Height to the current height range.
Upward Anti-Collision	U-0 U-9	0 shut down 1-9: The higher the number, the higher the sensitivity.
Downward Anti-Collision	d-0 d-9	0 shut down 1-9: The higher the number, the higher the sensitivity.
Display Decimal Point	F-0 F-1	The decimal point is not displayed. The decimal point is displayed.
Display Unit	L-0 L-1	Change the display to show height in centimeters. Change the display to show height in inches

TROUBLE SHOOTING

Error Code	Description/Resolution
Err1	Press and hold the down arrow to perform a reset.
hot	The desk is overheated. Allow the desk to rest for more than 18 minutes before operating.

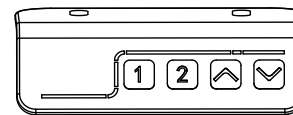

PT

CONFIGURAÇÃO AVANÇADA

Mantenha pressionados simultaneamente os botões "1" e "2" por 20 segundos até que o LED pisque. O menu contém 7 itens conforme a tabela abaixo.

Pressione "▲" ou "▼" respectivamente para realizar as configurações; mantenha pressionados os botões "1" e "2" por no mínimo 5 segundos até que "888" seja exibido para salvar a configuração atual.

Menu	Faixa de configuração	Observações
Altura mínima	73cm-108cm (28.7"-42.5")	O valor de configuração deve ser pelo menos 10cm (3.9") menor que a Altura Máxima.
Altura máxima	83cm-118cm (32.7"-46.5")	O valor de configuração deve ser pelo menos 10cm (3.9") menor que a Altura Máxima.
Altura inicial	0cm-30cm (0"-11.8")	Aumente a Altura Inicial para a faixa de altura atual.
Anti-colisão ascendente	U-0 U-9	0 desligado 1-9: Quanto maior o número, maior a sensibilidade.
Anti-colisão descendente	d-0 d-9	0 desligado 1-9: Quanto maior o número, maior a sensibilidade.
Exibir ponto decimal	F-0 F-1	O ponto decimal não é exibido. O ponto decimal é exibido.
Unidade de exibição	L-0 L-1	Altere a exibição para mostrar a altura em centí metros. Altere a exibição para mostrar a altura em polegadas.

RESOLUÇÃO DE PROBLEMAS

Código de erro	Descrição/Resolução
Err1	Pressione e segure a seta para baixo para executar uma redefinição.
hot	A mesa está superaquecida. Deixe-a descansar por mais de 18 minutos antes de operá-la.

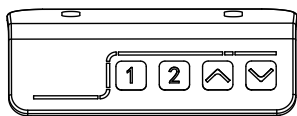

ES

CONFIGURACIÓN AVANZADA

Mantenga pulsados simultáneamente los botones "1" y "2" durante 20 segundos hasta que el LED parpadee. El menú contiene 7 elementos como se muestra en la tabla a continuación.

Pulse "↕" o "↘" respectivamente para realizar la configuración; mantenga pulsados los botones "1" y "2" durante no menos de 5 segundos hasta que se muestre "888" para guardar la configuración actual.

Menú	Rango de configuración	Observaciones
Altura mínima	73cm-108cm (28.7"-42.5")	El valor de configuración debe ser al menos 10cm (3.9") menor que la altura máxima.
Altura máxima	83cm-118cm (32.7"-46.5")	El valor de configuración debe ser al menos 10cm (3.9") menor que la altura máxima.
Altura inicial	0cm-30cm (0"-11.8")	Aumente la altura inicial al rango de altura actual.
Anticolisión ascendente	U-0 U-9	0 apagado 1-9: Cuanto mayor sea el número, mayor será la sensibilidad.
Anticolisión descendente	d-0 d-9	0 apagado 1-9: Cuanto mayor sea el número, mayor será la sensibilidad.
Mostrar punto decimal	F-0 F-1	El punto decimal no se muestra. El punto decimal se muestra.
Unidad de visualización	L-0 L-1	Cambie la visualización para mostrar la altura en centímetros. Cambie la visualización para mostrar la altura en pulgadas.

SOLUCIÓN DE PROBLEMAS

Código de error	Descripción/Resolución
Err	Presione y mantenga presionada la flecha hacia abajo para realizar un reinicio.
hot	El escritorio está sobrecalentado. Deje que el escritorio descanse más de 18 minutos antes de operarlo.

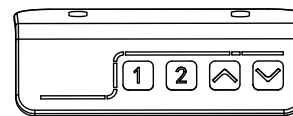

FR

PARAMÈTRES AVANCÉS

PARAMÈTRES AVANCÉS Maintenez enfoncés simultanément les boutons "1" et "2" pendant 20 secondes jusqu'à ce que le LED clignote. Le menu contient 7 éléments comme indiqué dans le tableau ci-dessous.

Appuyez sur "↕" ou "↘" respectivement pour effectuer les paramètres; maintenez enfoncés les boutons "1" et "2" pendant au moins 5 secondes jusqu'à ce que "888" s'affiche pour enregistrer le paramètre actuel.

Menu	Plage de paramétrage	Remarques
Hauteur minimale	73cm-108cm (28.7"-42.5")	La valeur de paramétrage doit être inférieure d'au moins 10cm (3.9") à la hauteur maximale.
Hauteur maximale	83cm-118cm (32.7"-46.5")	La valeur de paramétrage doit être inférieure d'au moins 10cm (3.9") à la hauteur maximale.
Hauteur de départ	0cm-30cm (0"-11.8")	Augmentez la hauteur de départ à la plage de hauteur actuelle.
Anti-collision ascendante	U-0 U-9	0 arrêté 1-9: Plus le nombre est élevé, plus la sensibilité est élevée.
Anti-collision descendente	d-0 d-9	0 arrêté 1-9: Plus le nombre est élevé, plus la sensibilité est élevée.
Affichage de la virgule décimale	F-0 F-1	La virgule décimale n'est pas affichée. La virgule décimale est affichée.
Unité d'affichage	L-0 L-1	Changez l'affichage pour montrer la hauteur en centimètres. Changez l'affichage pour montrer la hauteur en pouces.

DÉPANNAGE

Code d'erreur	Description/Résolution
Err	Appuyez et maintenez enfoncée la flèche vers le bas pour effectuer une réinitialisation.
hot	Le bureau est surchauffé. Laissez-le reposer plus de 18 minutes avant de l'utiliser.

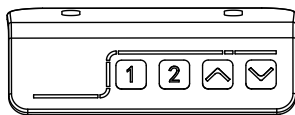

IT

IMPOSTAZIONI AVANZATE

Tenere premuti simultaneamente i pulsanti "1" e "2" per 20 secondi finché il LED non lampeggia. Il menu contiene 7 voci come mostrato nella tabella seguente. Premere rispettivamente "↕" o "↗" per eseguire le impostazioni; tenere premuti i pulsanti "1" e "2" per non meno di 5 secondi finché non viene visualizzato "888" per salvare l'impostazione corrente.

Menu	Intervallo di impostazione	Osservazioni
Altezza minima	73cm-108cm (28.7"-42.5")	Il valore di impostazione deve essere inferiore di almeno 10cm (3.9") rispetto all'Altezza Massima.
Altezza massima	83cm-118cm (32.7"-46.5")	Il valore di impostazione deve essere inferiore di almeno 10cm (3.9") rispetto all'Altezza Massima.
Altezza iniziale	0cm-30cm (0"-11.8")	Aumentare l'Altezza Iniziale all'intervallo di altezza corrente.
Anti-collisione verso l'alto	U-0 U-9	0 spento 1-9: Più alto è il numero, maggiore è la sensibilità.
Anti-collisione verso il basso	d-0 d-9	0 spento 1-9: Più alto è il numero, maggiore è la sensibilità.
Visualizza punto decimale	F-0 F-1	Il punto decimale non viene visualizzato. Il punto decimale viene visualizzato.
Unità di visualizzazione	L-0 L-1	Cambiare la visualizzazione per mostrare l'altezza in centimetri. Cambiare la visualizzazione per mostrare l'altezza in pollici.

RISOLUZIONE DEI PROBLEMI

Codice di errore	Descrizione/Risoluzione
Er1	Premere e tenere premuta la freccia verso il basso per eseguire un ripristino.
hot	La scrivania è surriscaldata. Lasciala riposare per più di 18 minuti prima di usarla.

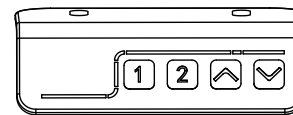

DE

ERWEITERTE EINSTELLUNGEN

Halten Sie die Tasten "1" und "2" gleichzeitig 20 Sekunden gedrückt, bis die LED blinkt. Das Menü enthält 7 Einträge, wie in der folgenden Tabelle aufgeführt. Drücken Sie jeweils "↕" oder "↗", um die Einstellungen vorzunehmen; halten Sie die Tasten "1" und "2" mindestens 5 Sekunden gedrückt, bis "888" angezeigt wird, um die aktuelle Einstellung zu speichern.

Menü	Einstellbereich	Hinweise
Mindesthöhe	73cm-108cm (28.7"-42.5")	Der eingestellte Wert muss mindestens 10cm (3.9") kleiner als die Maximalhöhe sein.
Maximalhöhe	83cm-118cm (32.7"-46.5")	Der eingestellte Wert muss mindestens 10cm (3.9") kleiner als die Maximalhöhe sein.
Anfangshöhe	0cm-30cm (0"-11.8")	Erhöhen Sie die Anfangshöhe auf den aktuellen Höhenbereich.
Aufwärts-Antikollision	U-0 U-9	0 ausgeschaltet 1-9: Je höher die Zahl, desto höher die Empfindlichkeit.
Abwärts-Antikollision	d-0 d-9	0 ausgeschaltet 1-9: Je höher die Zahl, desto höher die Empfindlichkeit.
Dezimalpunkt anzeigen	F-0 F-1	Der Dezimalpunkt wird nicht angezeigt. Der Dezimalpunkt wird angezeigt.
Anzeigeeinheit	L-0 L-1	Ändern Sie die Anzeige, um die Höhe in Zentimetern anzuzeigen. Ändern Sie die Anzeige, um die Höhe in Zoll anzuzeigen.

FEHLERBEHEBUNG

Fehlercode	Beschreibung/Lösung
Er1	Drücken und halten Sie die Pfeil nach unten, um einen Reset durchzuführen.
hot	Der Schreibtisch ist überhitzt. Lassen Sie ihn mehr als 18 Minuten ruhen, bevor Sie ihn bedienen.

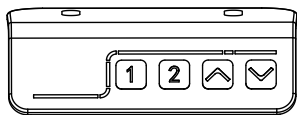

ZH 高级设置

同时按住“1”键和“2”键 20 秒，直到 LED 指示灯闪烁。菜单包含以下 7 个项目，如下表所示。分别按“↶”或“↷”键进行设置；
按住“1”键和“2”键不少于 5 秒，直到显示“888”，即可保存当前设置。

菜单	设置范围	备注
最低高度	73cm-108cm (28.7"-42.5")	设置值应至少比最高高度小 10cm (3.9")。
最高高度	83cm-118cm (32.7"-46.5")	设置值应至少比最高高度小 10cm (3.9")。
起始高度	0cm-30cm (0"-11.8")	将起始高度调整至当前高度范围。
上升防碰撞	U-0 U-9	0: 关闭 1~9: 数值越大，灵敏度越高。
下降防碰撞	d-0 d-9	0: 关闭 1~9: 数值越大，灵敏度越高。
显示小数点	F-0 F-1	不显示小数点。 显示小数点。
显示单位	L-0 L-1	将显示切换为厘米单位。 将显示切换为英寸单位。

故障排查

错误代码	说明 / 解决方法
Err	按住向下箭头执行重置。
hot	升降桌过热。请让桌子休息超过 18 分钟后再操作。



Dive into your next dimension

English

For more detailed information, please visit our official website.

Português

Para obter informações mais detalhadas, visite o nosso site oficial.

Español

Para obtener información más detallada, visite nuestro sitio web oficial.

Français

Pour plus d'informations détaillées, veuillez consulter notre site officiel.

Italiano

Per maggiori informazioni dettagliate, visita il nostro sito ufficiale.

Deutsch

Für weitere detaillierte Informationen besuchen Sie bitte unsere offizielle Website.

中文

如需了解更多详细信息，请访问我们的官方网站。



<https://xyzpcgear.com/downloads/#gamingdesks>